

1

Here is a 1 cm square grid. Some of the grid is shaded.

[2018]

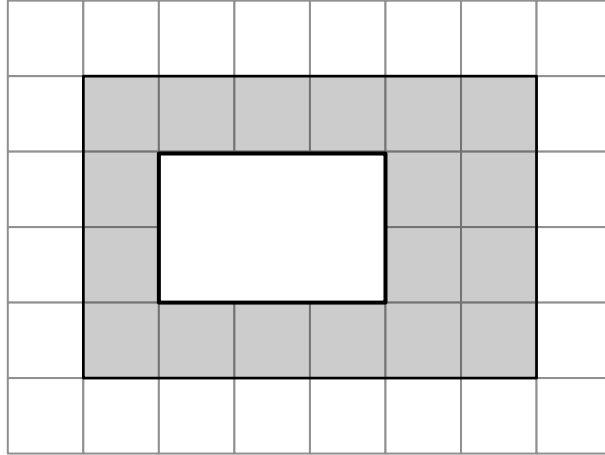

What is the area of the shaded shape?

[1 mark]

2

Here is a 1 cm square grid. Some of the grid is shaded.

[2005]

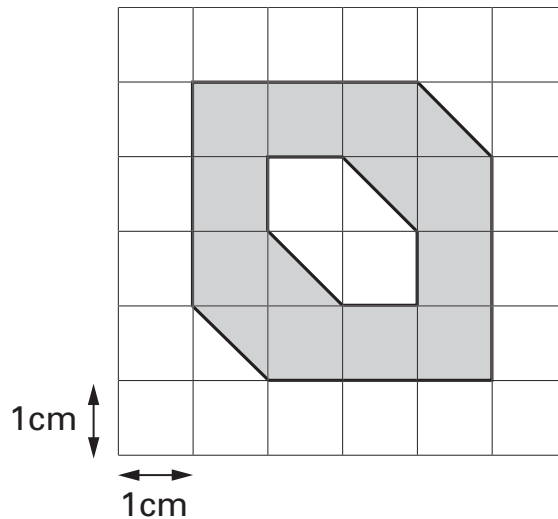

What is the area of the shaded shape?

[1 mark]

3

[2002]

Match each shape on the left to one with **equal area** on the right.

One has been done for you.

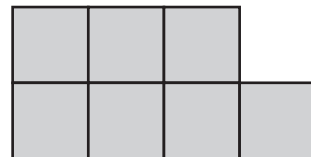
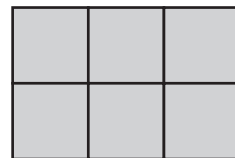
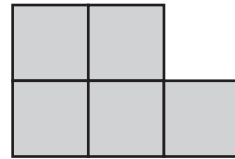
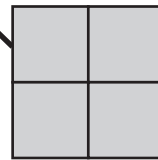
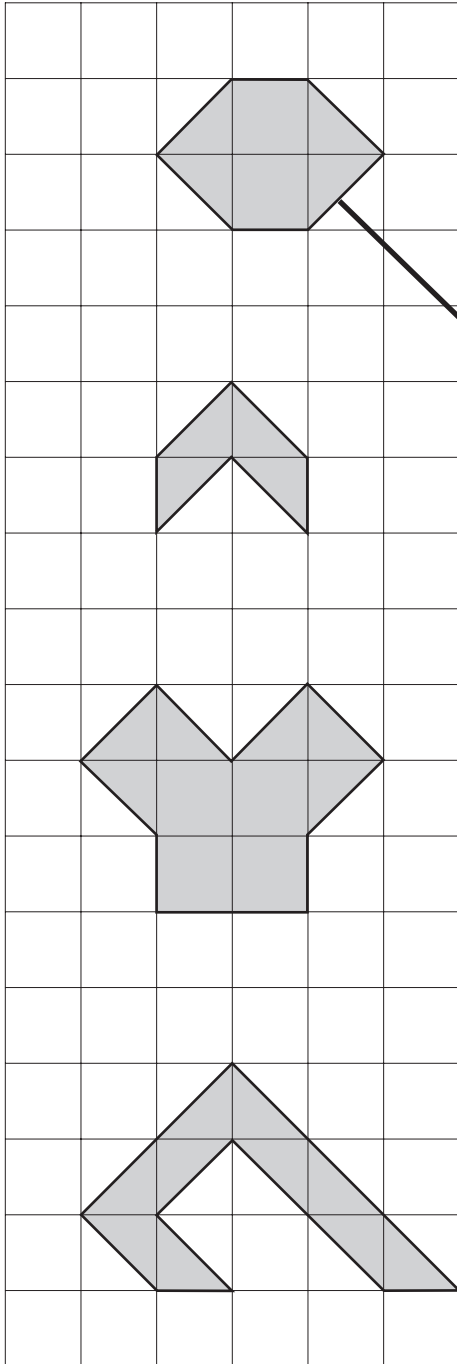

[2 marks]

4

Here is a set of 20 squares around a shaded space.

[2013]

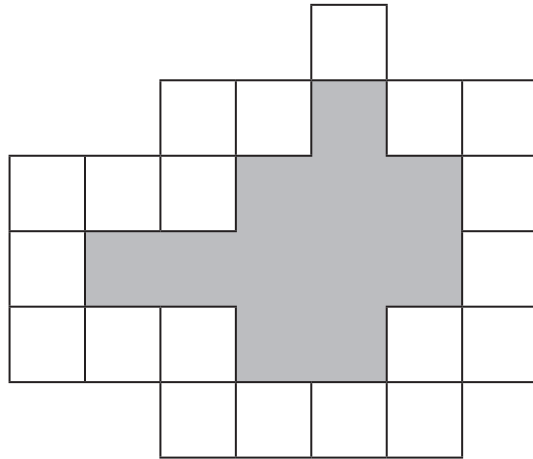

What is the area of the shaded space?



squares

[1 mark]

5

Here is a shaded shape on a 1 cm square grid.

[2012]

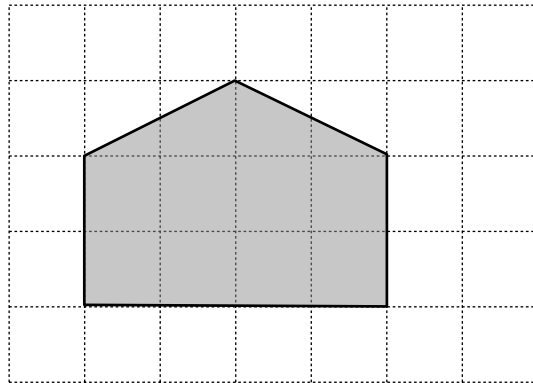

What is the area of the shaded shape?

cm<sup>2</sup>

[1 mark]

6

Here are some shapes on a 1 cm square grid.

[2011]

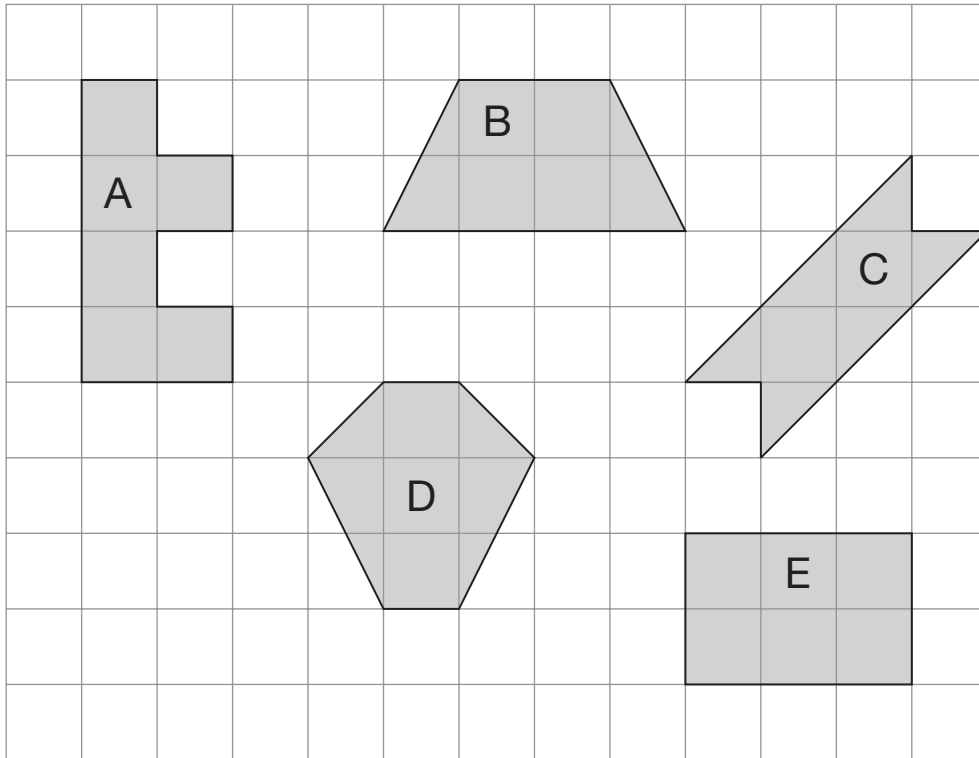

What is the **perimeter** of shape A?



Write the letter of the shape that has the **smallest area**.



[2 marks]

7

Here are five shapes on a regular grid.

[2012]

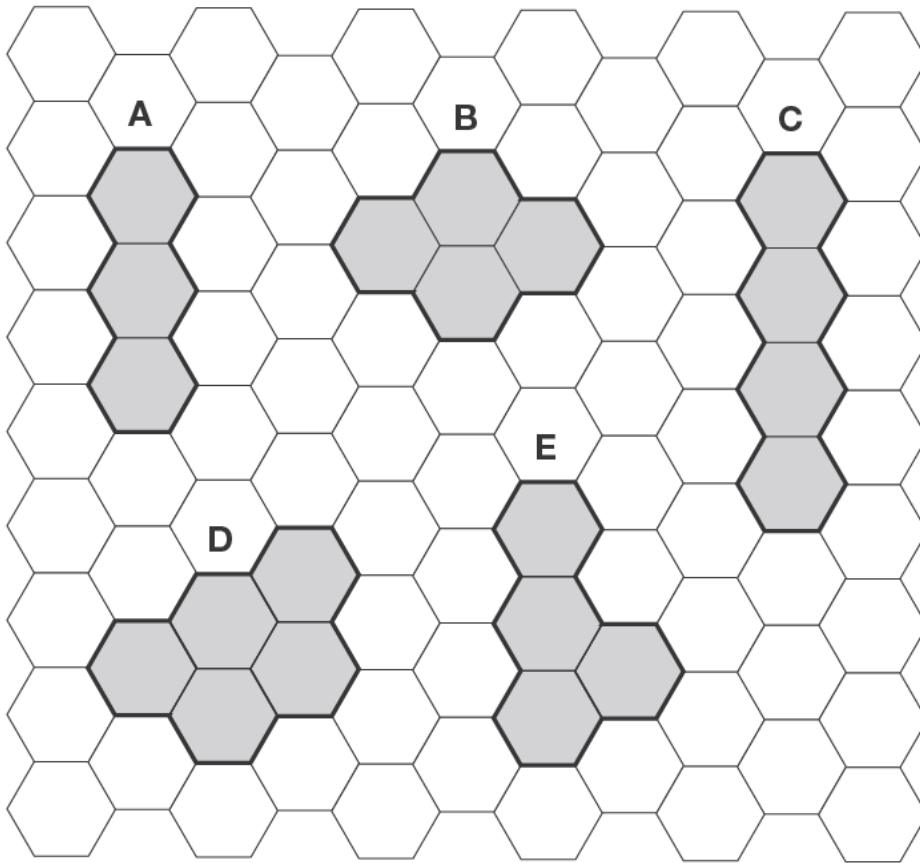

Which shape has the longest perimeter?

[2 marks]

8

This shape is made from 4 shaded squares.

[2006]

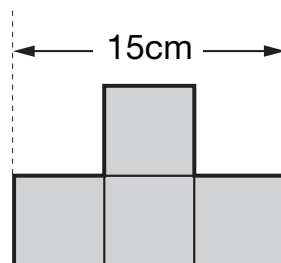

Not  
actual size

Calculate the perimeter of the shape.

[1 mark]

9

Here is a grid of regular hexagons.

[2007]

The shaded shape has an area of 3 hexagons and a perimeter of 14 cm.

Draw another shape on the grid which has an **area** of 4 hexagons and a **perimeter** of 14 cm.

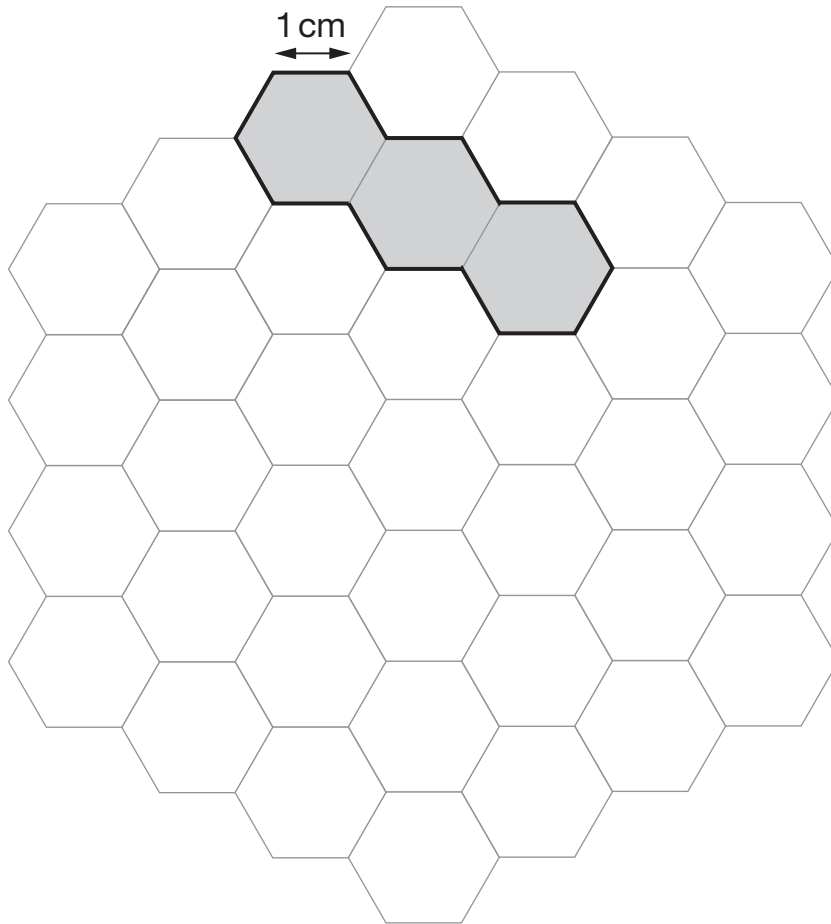

[1 mark]

10

Millie has some star-shaped tiles.

[2004]

Each edge of a tile is 5 centimetres long.

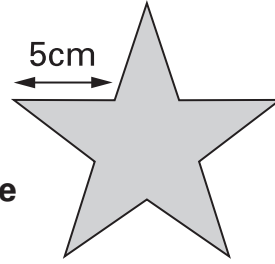

Not actual size

She puts two tiles together to make this shape.

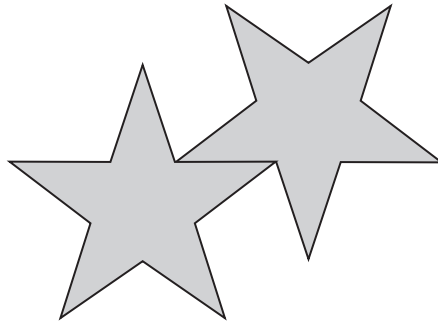

Work out the perimeter of Millie's shape.



[1 mark]

11

Here is a parallelogram on a 1 cm square grid.

[Extra]

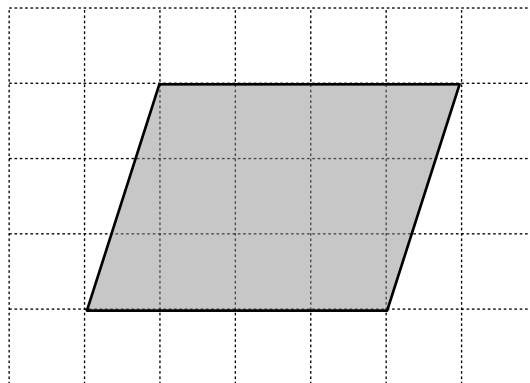

What is the area of the parallelogram?

[1 mark]

12

This shape is made out of four identical curves.

[2014]

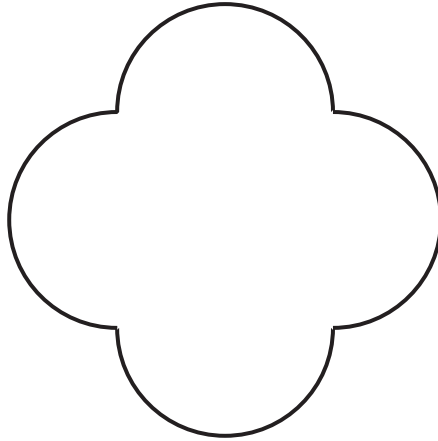

**Not  
actual  
size**

The perimeter of the shape is 28 centimetres.

A new shape is made out of curves of the same size.

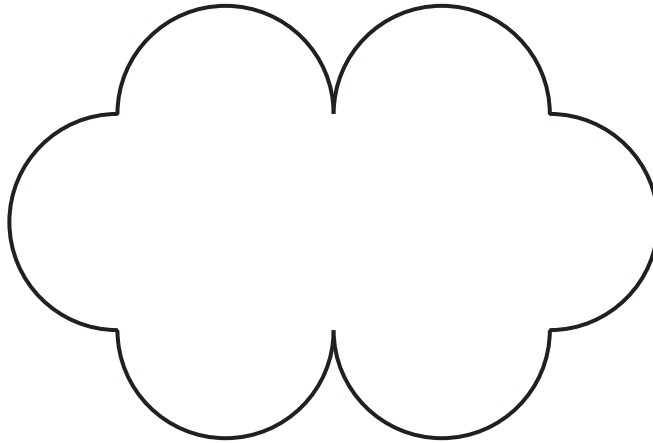

What is the perimeter of the new shape?

Show your method

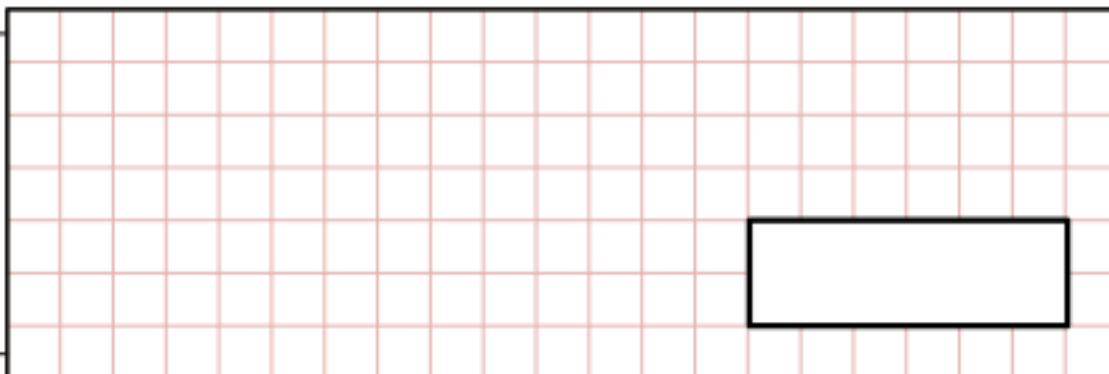

[2 marks]



13

Liam has two rectangular tiles like this.

[2000]

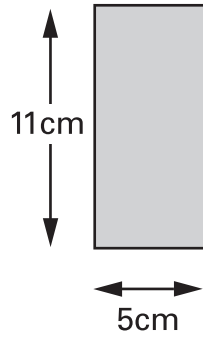

He makes this L shape.

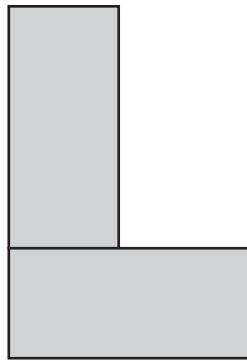

What is the perimeter of Liam's L shape?

[1 mark]

14

The area of a rugby pitch is 6,108 square metres.

[2016S]

A football pitch measures 112 metres long and 82 metres wide.

How much larger is the area of the football pitch than the area of the rugby pitch?

Show your method

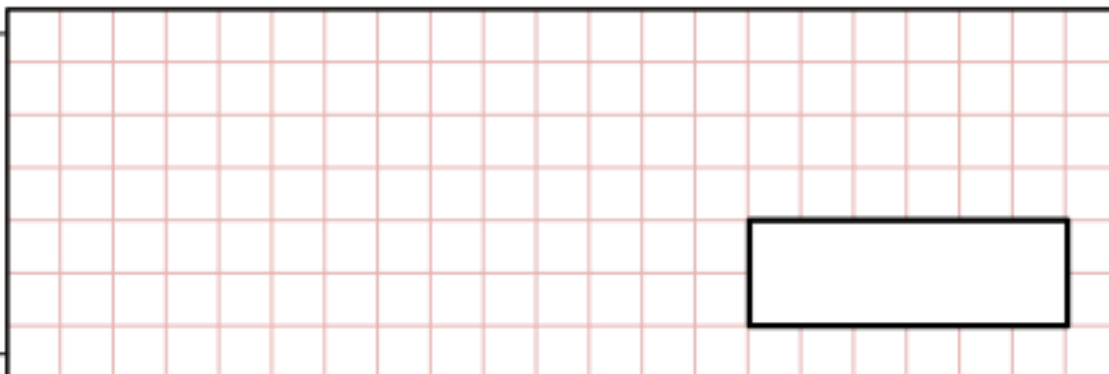

[2 marks]

15

Lara has some identical rectangles.

[2009]

They are 7 centimetres long and 2 centimetres wide.

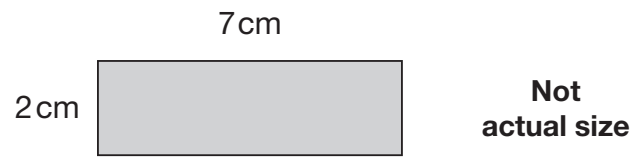

She uses **five** of her rectangles to make the large rectangle below.

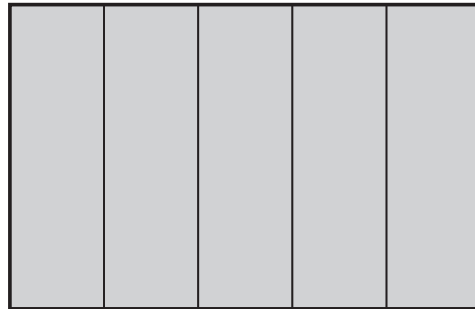

What is the **perimeter** of the large rectangle?



What is the **area** of the large rectangle?



[2 marks]

16

[2001]

Lauren has **three small equilateral triangles** and **one large equilateral triangle**.

The small triangles have sides of **7 centimetres**.

Lauren makes this shape.

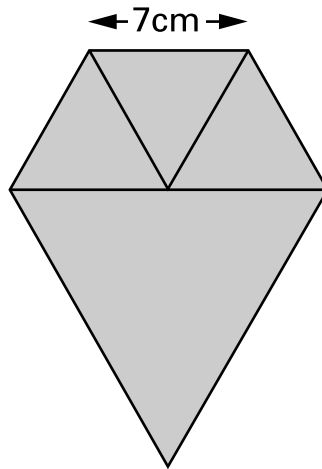

Not actual size

Calculate the **perimeter** of the shape.

Do **not** use a ruler.

[2 marks]

17

[Extra]

Here is a triangle on a 1 cm square grid.

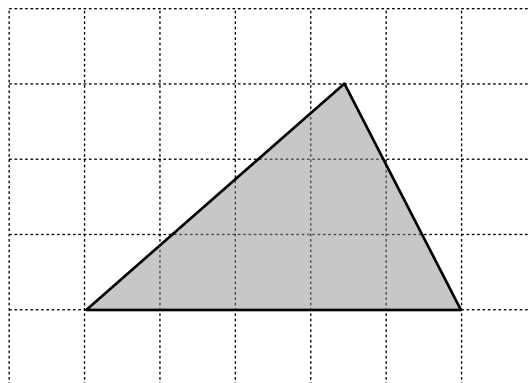

What is the area of the triangle?

[1 mark]

18

A square tile measures 20cm by 20cm.

[2017]

A rectangular tile is 3cm **longer** and 2cm **narrower** than the square tile.

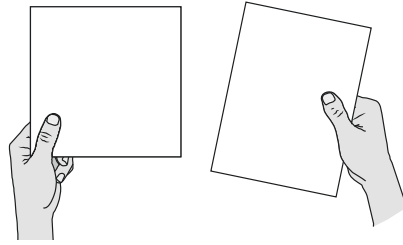

What is the **difference in area** between the two tiles?

Show your method



[3 marks]

19

[2010]

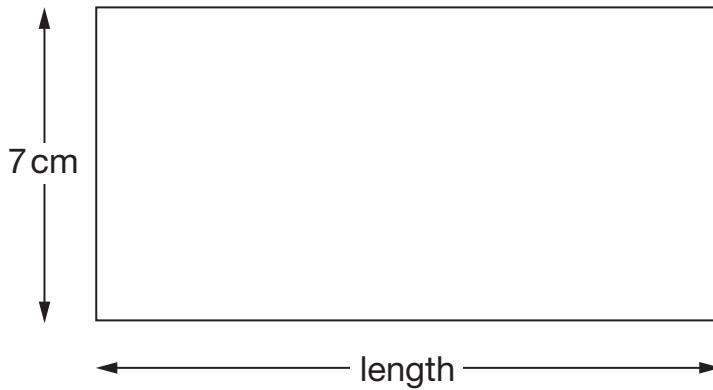

**Not  
actual  
size**

The perimeter of this rectangle is 50 centimetres.

Calculate the length of the rectangle.

Show your method

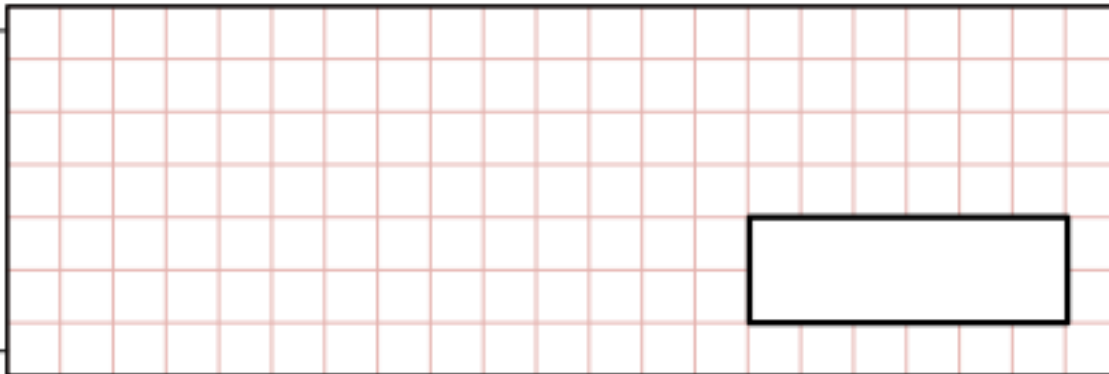

[2 marks]

20

What is the area of this shape?

[2002]

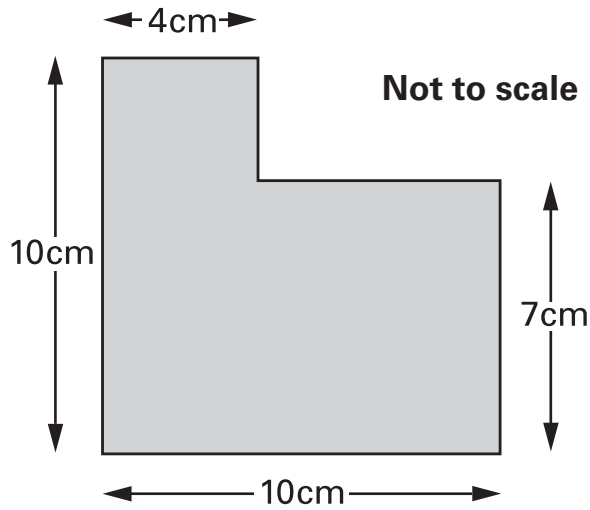

Show your method

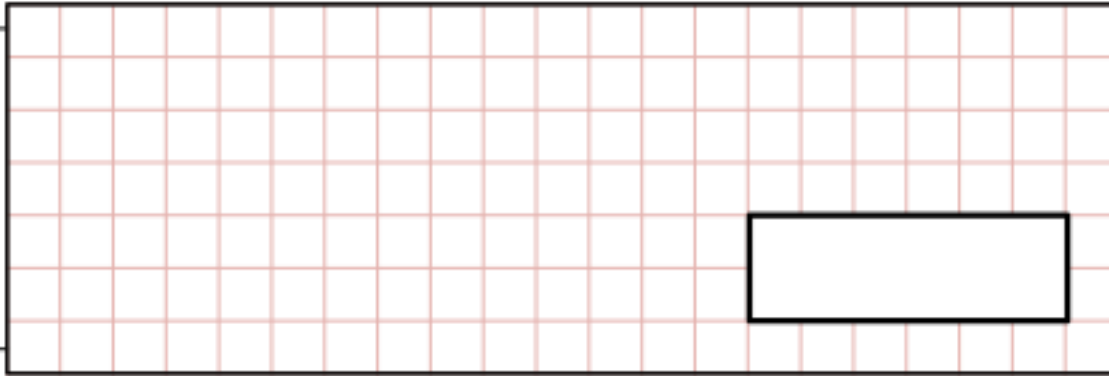

[2 marks]

21

This shape is drawn on a centimetre square grid.

[Extra]

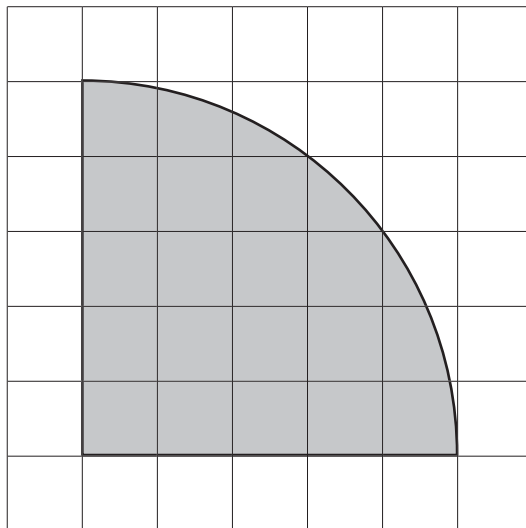

Estimate the area of the shape.

[1 mark]

Chen has some right-angled triangular tiles.

[2015]

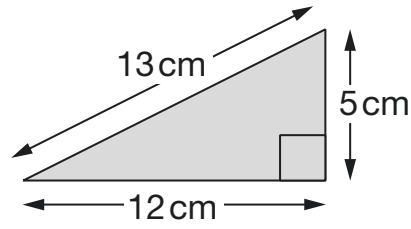

**Not  
actual  
size**

He makes this shape with four of his triangular tiles and three square tiles.

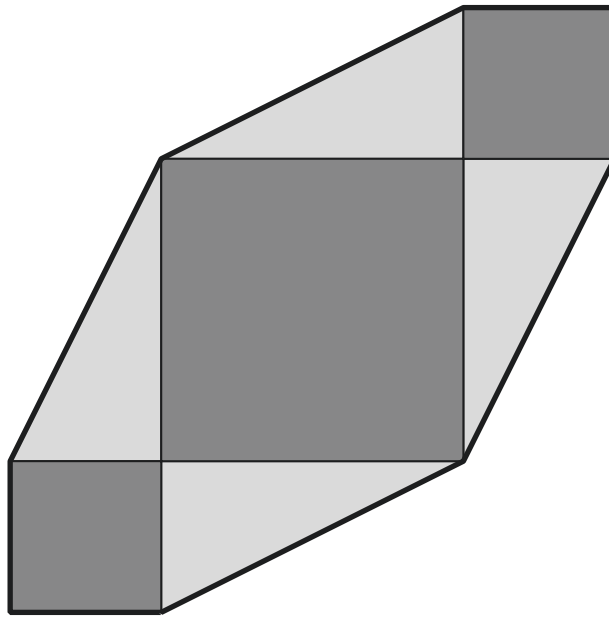

**Not  
actual  
size**

What is the **perimeter** of Chen's shape?

Show your method

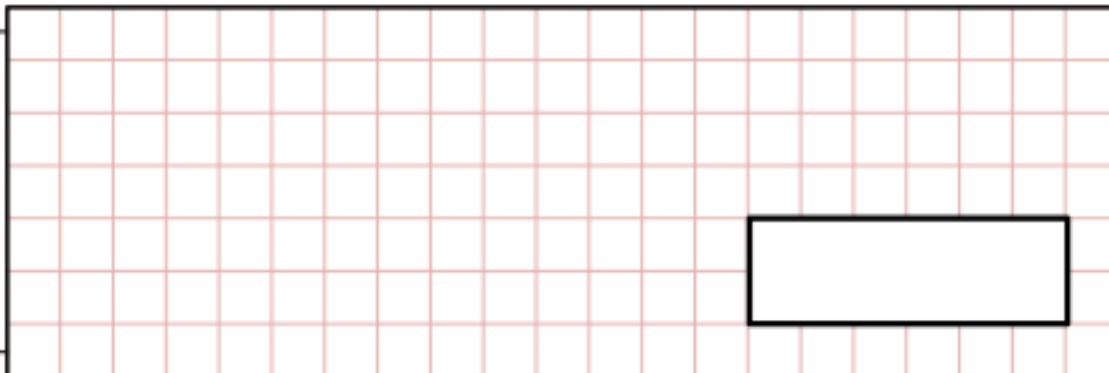

[2 marks]

23

The perimeter of a square is 72 centimetres.

[2008]



Not actual size

The square is cut in half to make two identical rectangles.

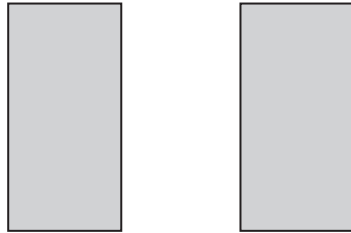

What is the perimeter of one rectangle?

Show your method

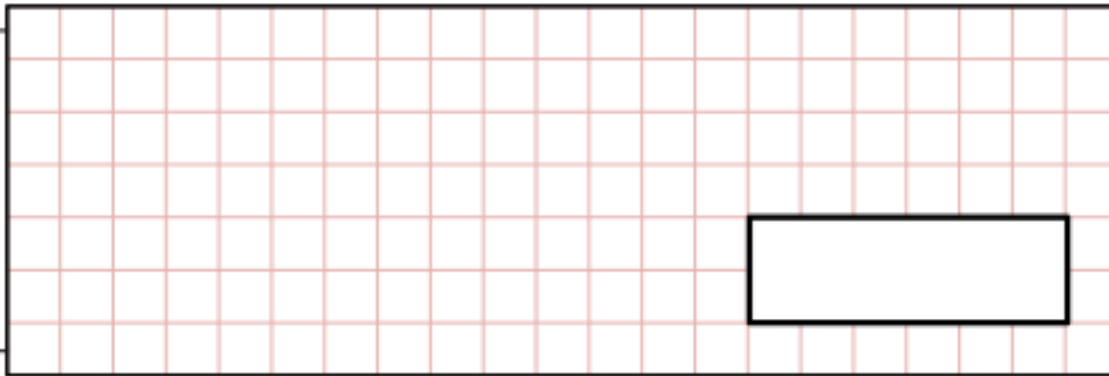

[2 marks]

24

The perimeter of a rectangle is one metre.

[Extra]

Each longer side is 36 centimetres.

What is the length of each shorter side?

Show your method

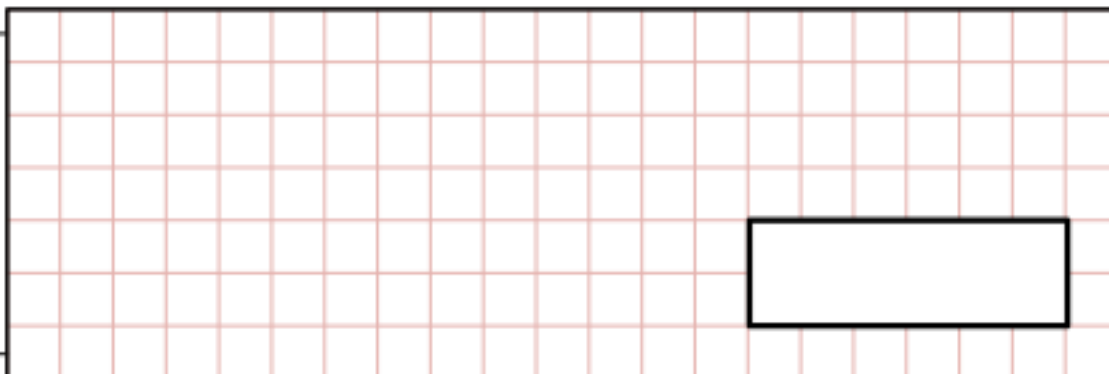

[2 marks]

25

On the centimetre square grid below, draw a parallelogram that has an area of  $8 \text{ cm}^2$

[Extra]

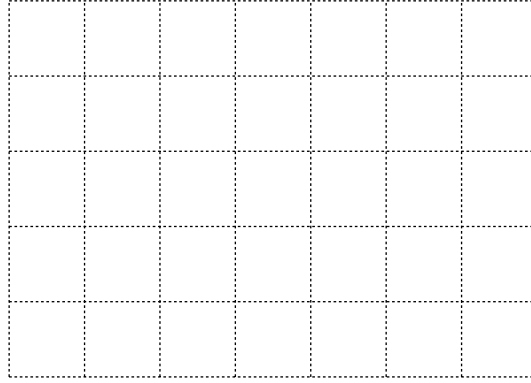

[1 mark]

26

A white square is painted in one corner of a grey square.

[2007]

Each side of the white square is half the length of a side of the grey square.

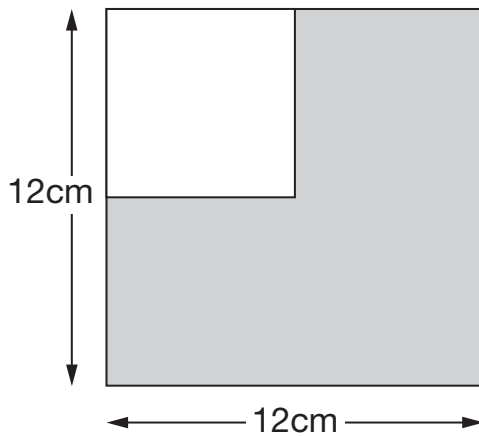

Not actual size

What is the area of the grey section?

Show your method

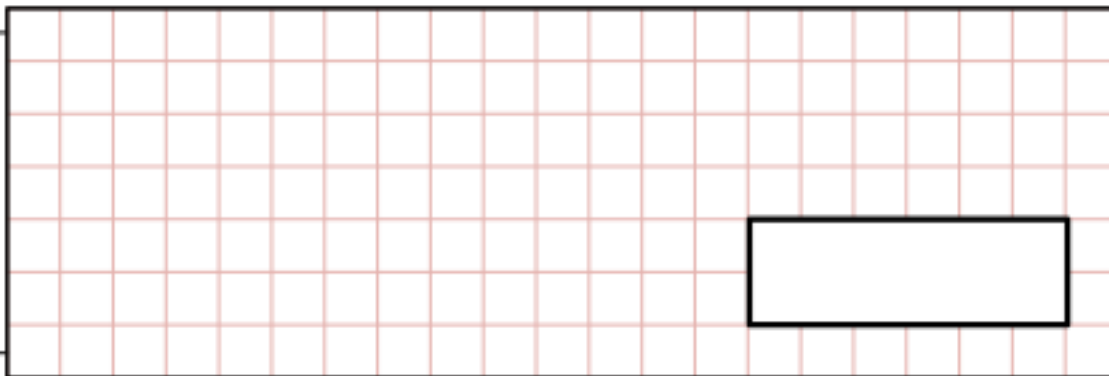

[2 marks]



27

On the centimetre square grid below, draw a triangle that has an area of  $5 \text{ cm}^2$

[Extra]

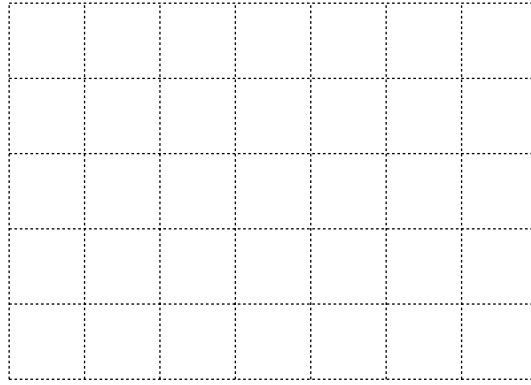

[1 mark]

28

Twelve rectangles, all the same size, are arranged to make a square, as shown in the diagram.

[2000]

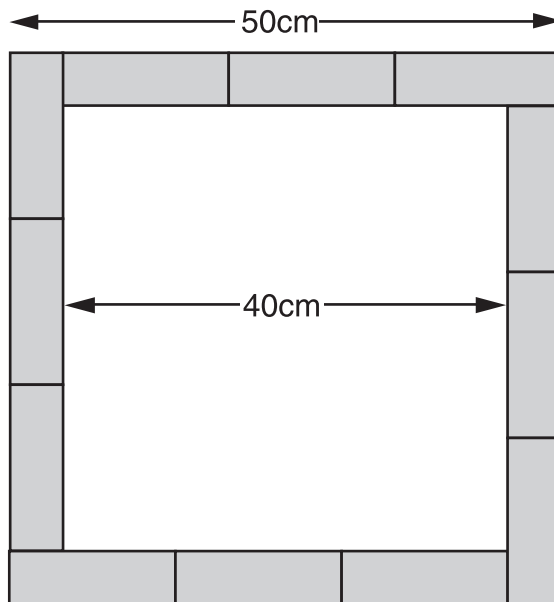

Calculate the area of one of the rectangles.

Show your method

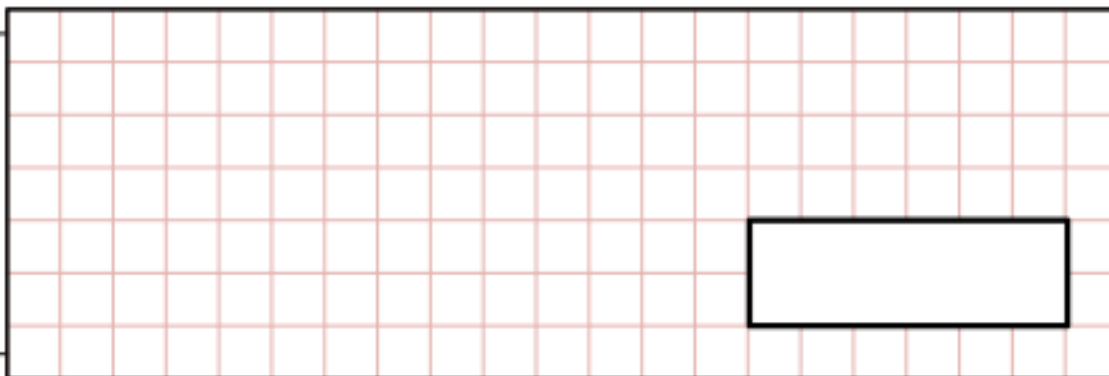

[2 marks]

29

Calculate the area of the parallelogram?

[Extra]

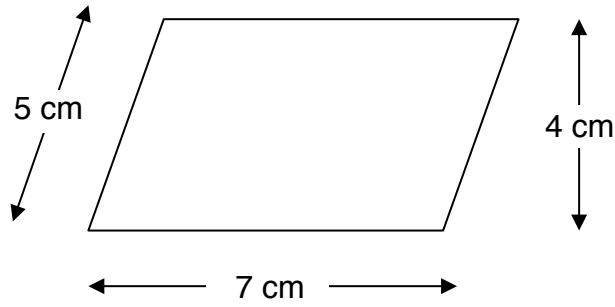

cm<sup>2</sup>

[1 mark]

30

Here is an equilateral triangle inside a square.

[2004]

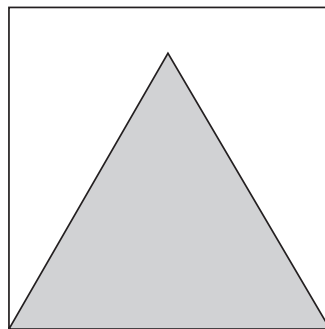

Not actual size

The perimeter of the triangle is 48 centimetres.

Calculate the perimeter of the **square**?

Show your method

A large grid for showing the method to solve the problem. A small empty rectangular box is provided for the final answer.

[2 marks]

31

Calculate the area of the triangle?

[Extra]

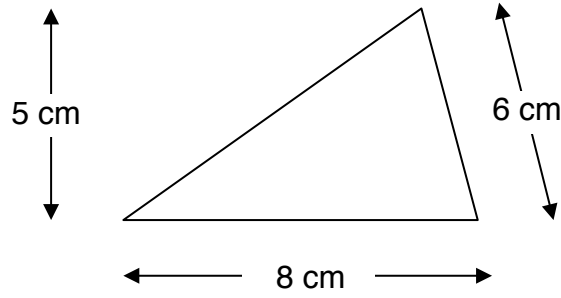

cm<sup>2</sup>

[1 mark]

32

The diagram shows 4 identical shaded triangles in a rectangle.

[2001]

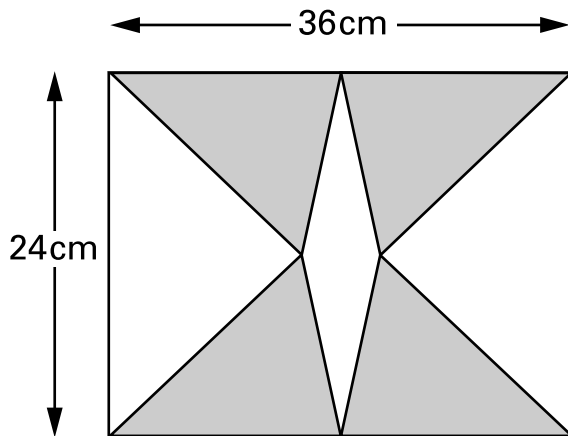

Not actual size

The rectangle measures 36 centimetres by 24 centimetres.

Calculate the area of one shaded triangle.

Show your method

[2 marks]

33

Jody has some triangular tiles like this:

[Extra]

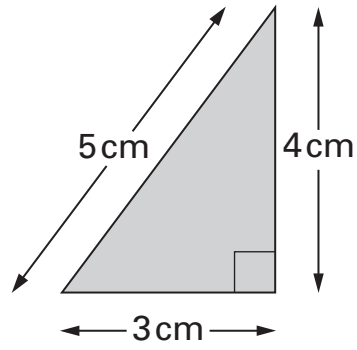

I use two of these tiles to make different shapes.

For each shape, work out its perimeter.

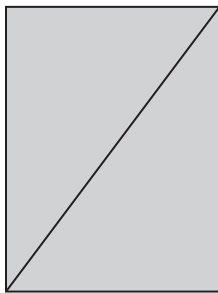

The perimeter of the rectangle is:

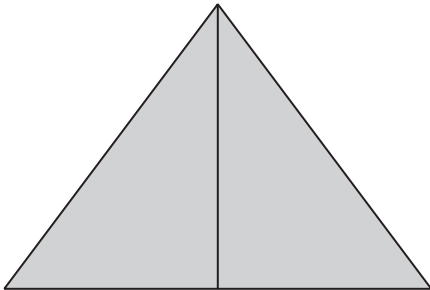

The perimeter of the isosceles triangle is:

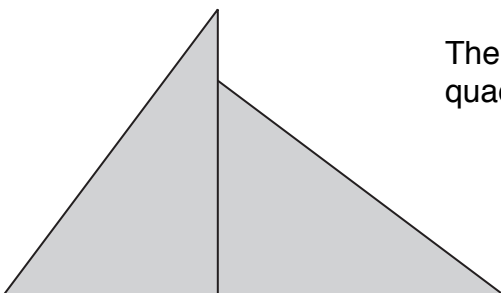

The perimeter of the quadrilateral is:

[3 marks]